

DELTA Block Wall Details
N.T.S.

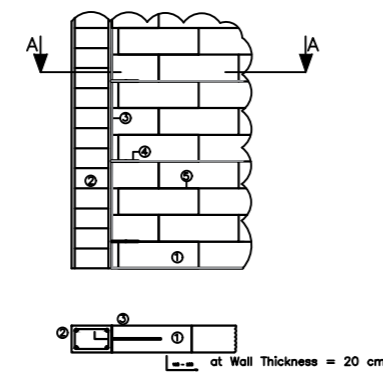

- 1- Masonry Wall of Delta Block
- 2- Reinforced Concrete Column
- 3- A layer of cement sand mortar
- 4- Wall Reinforcement , Stirrups + Wire mesh
- 5- Delta mortar

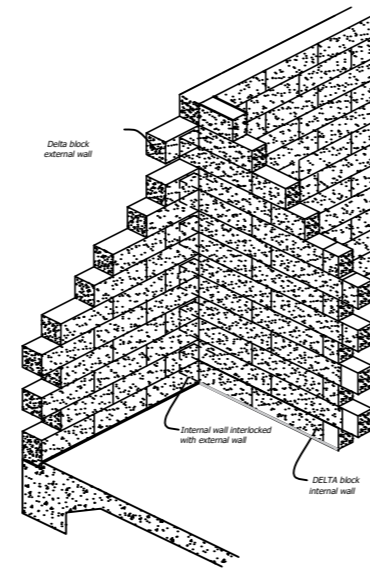

Intersection Between DELTA Block Walls
N.T.S.

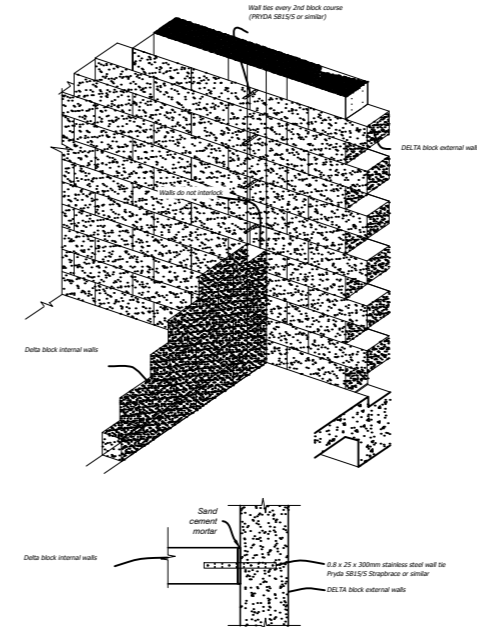

Alternative Internal to External Wall Intersection
N.T.S.

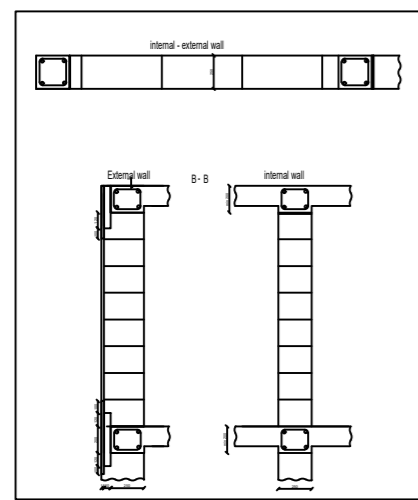
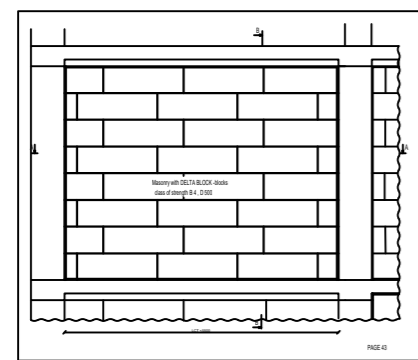

Typical Wall Section
N.T.S.

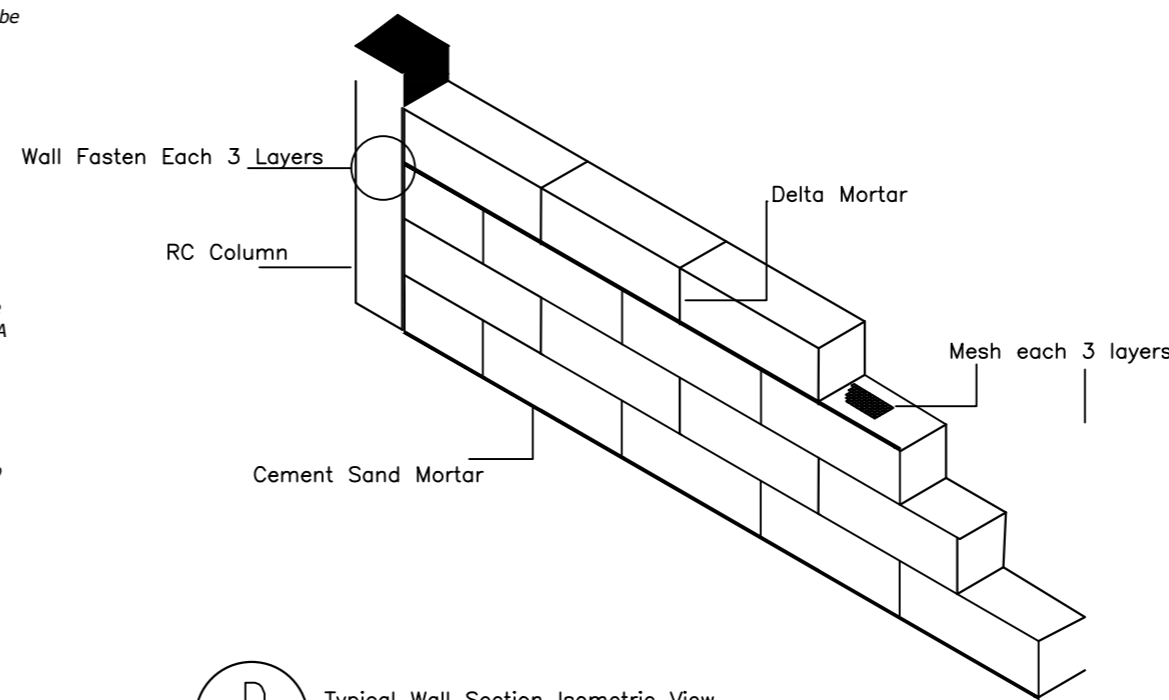
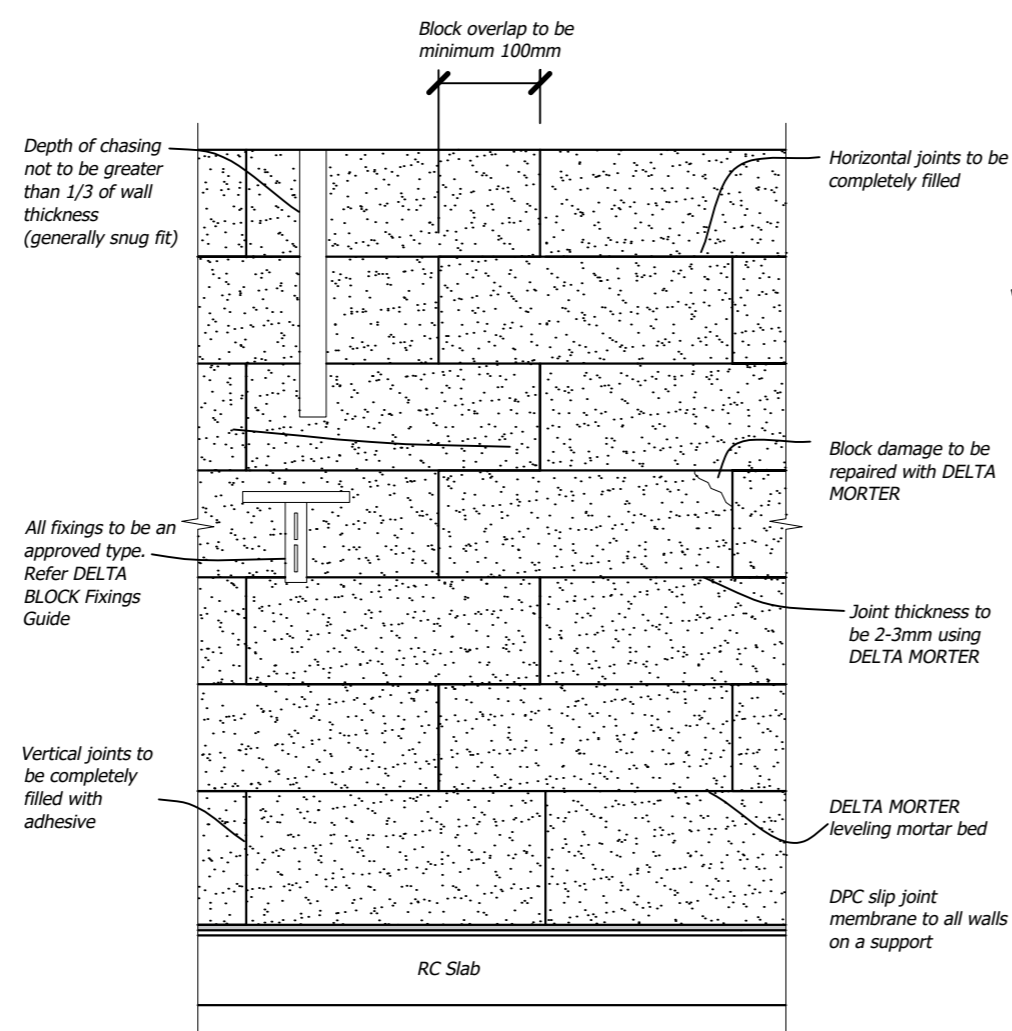

Typical Wall Section Isometric View
N.T.S.



DELTA BUILDING SYSTEMS
Member of
PLENA GROUP

PRODUCED BY AN AUTODESK STUDENT VERSION

Delta Block Wall Details

مقياس رسم / كما باللوحه		التصميم مقدم من	
 DELTA BUILDING SYSTEMS Member of PLENA GROUP Tel: (+202) 2527789/94/95/96, Fax: (+202) 2527797 35 B Saray El Maadi - Corniche El Nile st. , Cairo , Egypt web:www.plenaegypt.com-email: essam.samy@plenaegypt.com		م/احمد مرسى م/عصام سامى	
رقم اللوحه	DWG تصنيف	رقم المشروع	م/عصام سامى
0050	A	891/10	01